

CORNHOLE SUPPLIES AND TOOLS

Building dimensions supplied by www.cornhole-game.org , the #1 supplier of cornhole bags and boards on the internet.



SUPPLIES

QUANTITY

- (1) 1/2" FIBERBOARD (PLYWOOD) SHEET - 4' X 8'
- (3) 2" X 4" BOARDS - 8' LONG
- (1) BOX DECK SCREWS

- PINT PRIMER PAINT
- (2) CANS COLOR PAINT (GLOSS ENAMEL)
- (1) COMPASS OR SUITABLE FACSMILE
(PENCIL AND STRING)



TOOLS

TAPE MEASURE
JIG SAW
DRILL
CIRCULAR / MITRE SAW
PAINTING SUPPLIES
150 GRIT SANDPAPER

CORNHOLE PLANS



STEP ONE:

Take 4' x 8' sheet of fiberboard (smooth plywood) and cut into four (4) equal sections, all 2' x 4' in dimension. Then take (1) of those 2' x 4' sections and cut that into 4 equal sections, all 11 1/2" x 2'.



Tip: Have the supply / lumber store cut the fiberboard for you. Most of them will do all of the cuts for you and save you a lot of time and effort.

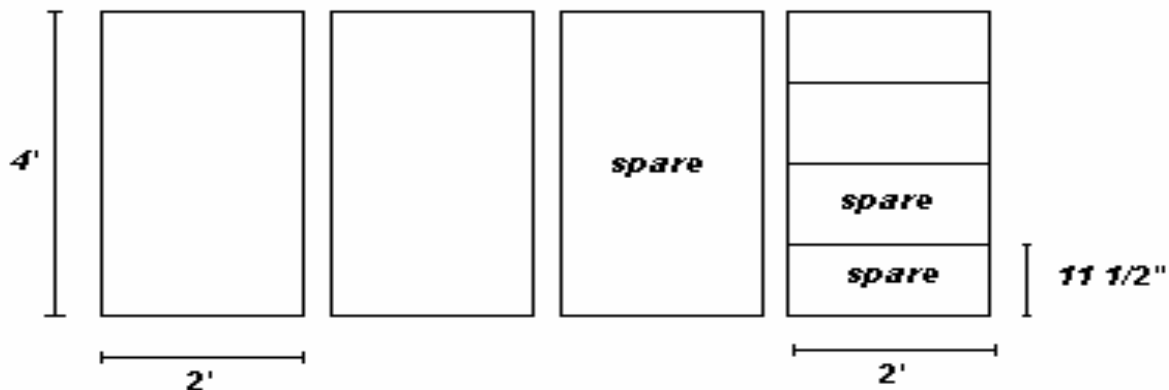

STEP TWO:

Take (2) of the 2' x 4" x 8' boards and cut them into four (4) equal lengths, all 3' 11 1/2" in length.



Tip: These boards will become the sides of your cornhole platform. The reason for the 3' 11 1/2" length is for the rear riser later in the assembly process.

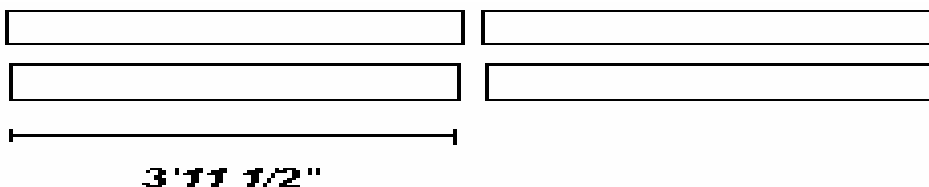

After cutting, you are left with (3) 2' x 4' platforms and (4) 11 1/2" x 2' risers. (1) of the platforms and (2) of the risers will be spares or extra. Save them!



STEP THREE:

Next take each of the 3' x 11 1/2" boards and affix them with deck screws to each of the long sides of the (2) platforms. Set the board on edge and position them flush with the projected bottom of the platform, leaving 1/2" gap at the projected top of the platform.

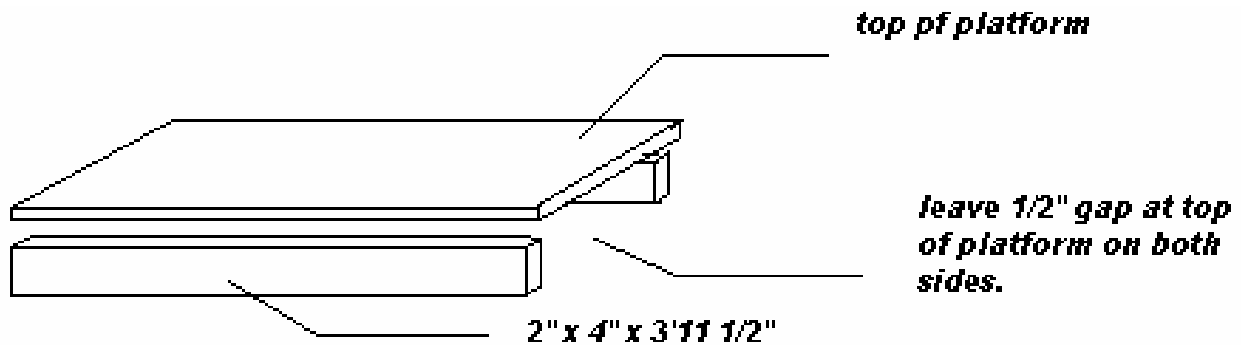

STEP FOUR:

Measure between the side rails boards for the exact measurement for the top and bottom rails on each platform. Then cut the remaining 2" x 4" to each measurement.

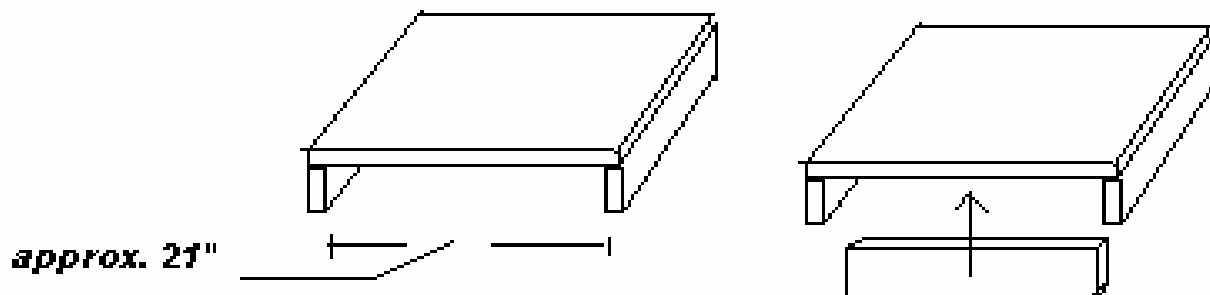

Tip: Note that this is an inside measurement, and due to the varying board widths, each measurement may be slightly different. It is usually approximately 21", but it pays to double check.



STEP FIVE:

Now affix these top and bottom rails, again on edge, to the bottom of the platform with deck screws in between the side rails.

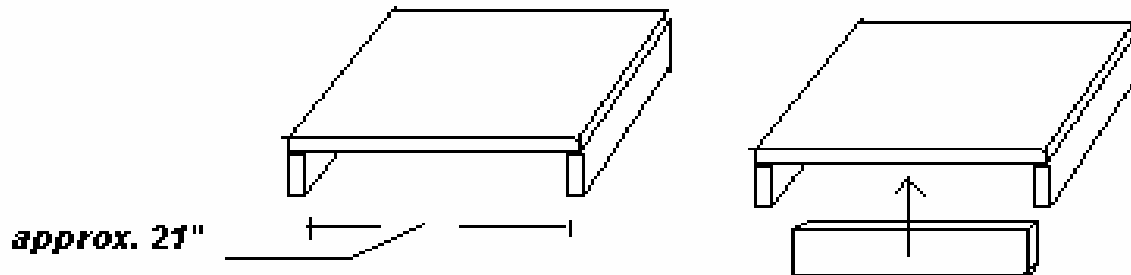

Tip: Again be sure to make the top rails flush with the side rails thus leaving a $\frac{1}{2}$ " gap at the top of the platform.



STEP SIX:

Set the platform on the ground (right side up) and locate the top of the platform (the side that has the $\frac{1}{2}$ " gap). Now find the proper location for the "cornhole" by pinpointing the center of the "cornhole" which should be 12" from each side and 9" from the top. Mark this center.

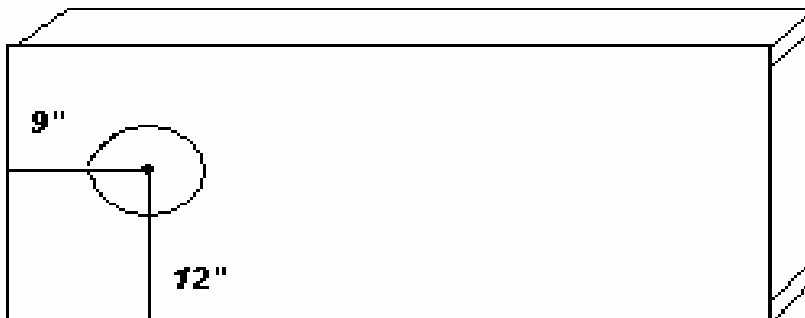



STEP SEVEN:

Taking the center of the “Cornhole”, you must draw a circle, 3” in radius (6” in circumference). There are several ways to do this, but the easiest way is to take a compass, set it to 3” and draw a circle around the center.



Tip: If you don’t have a compass, wrap a piece of string around a nail and connect a pencil to the other side 3” from the nail. Hold the nail in the center and draw a circle.



STEP EIGHT:

After drawing the circle, use a drill with a large drill bit (1/2” or more) and drill a starter hole on the inside of the circle, on the edge of the line. Then insert the blade from your jig saw inside the hole and cut around the circle.

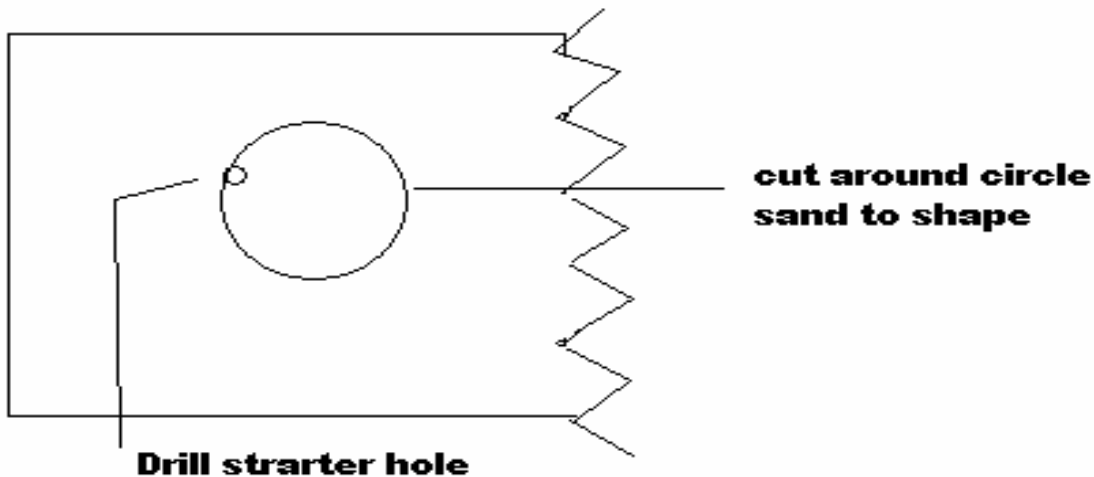

Use sandpaper to shape any imperfections in the hole.



STEP NINE:

Now take one of the previously cut 11 ½" x 2' boards and affix that to the top of the platform. This would go on the side with the cornhole and fit exactly under that ½" gap (overhang) and be connected with deck screws to the wood underneath the platform.

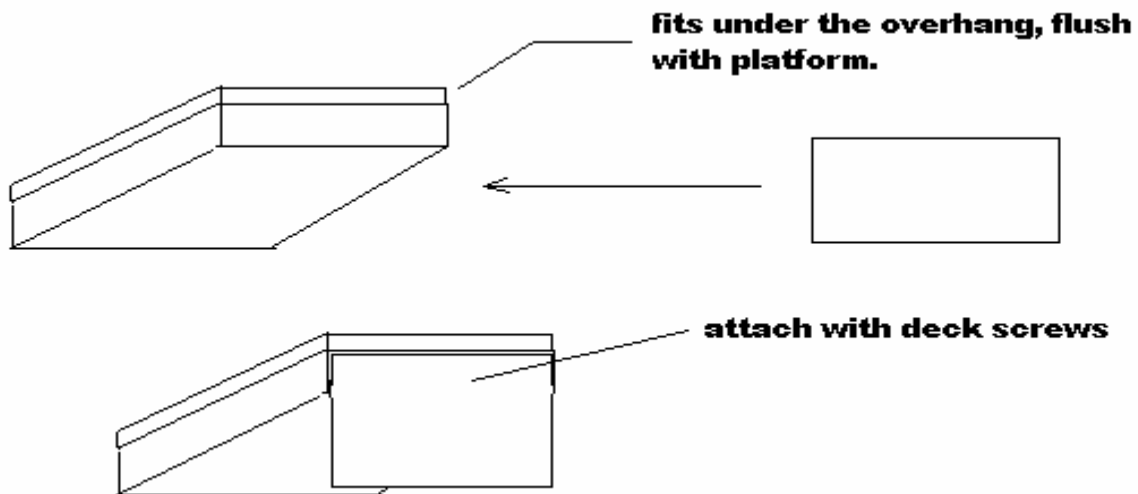

Tip: Here's an alternative. If you don't like the fixed rear, although it does last longer and is more stable, some prefer collapsible legs in the rear. To do this there are two main methods.

#1 : First drill a hole in both sides of the side rails in the middle of the rail, approximately 4" from the top of the platform. Then cut two legs approximately 12" long and drill a hole in both of the legs near the top. You do not have to be exact here, but drill the holes so that the legs will clear the inside of the platform when rotated up inside the platform. Simply attach the legs to the platform with a bolt and wing nut screw, placing large washers on both sides. Make sure when loosened that the legs rotate up inside the platform.

Now tighten the bolts with the legs extended (the legs should be angled a little to the rear). Now measure each leg from the top of the platform. Make a line (level to the ground) at the 12" measurement.

Do this for each leg individually. Then loosen and remove the legs. Cut the legs at the previous mark with your mitre/circular saw and reattach the legs to the platform. The rear of the platform should now stand 12" off the ground.

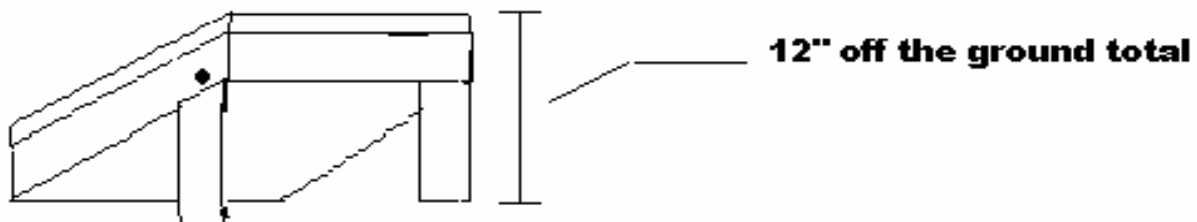

If you prefer another method, there is the hinge method.

Do not drill any holes in the side rails or legs, however cut two legs approximately 12" long and screw a regular hardware store hinge to the top of each of the legs. Then screw the hinge into the rear rail adjacent to the side rail. Position the hinge so that the legs retract inside the platform.

Next extend the legs into the playing position and measure down from the top of the platform exactly 12". Draw a line, level with the ground at that mark.

Remove the legs, cut at the desired length and reattach. Either way will allow for easier transport and convenience, however you may forfeit some stability.

The platform is now complete and only your own imagination is the limitation to the designs and patterns you can create on the platform.



Painting Tips:

You should use a primer on the entire platform first. This will not only hide and imperfections, but make it more secure to dampness and water later on. The primer should be latex/enamel and is readily available in stores.

As for the platform surface, a gloss paint should be used and can be done in many ways. I found that spray paint, in the gloss variety work wonders and was easy to apply. Buy some tape and make any design you like, or buy stickers and support you local sports teams.



STEP TEN:

Of course, the last step is getting the bags. If you planned ahead you might already have them. While most people don't mind building a set of cornhole boards, bags are another story. If that's the case with you, you can buy a set of bags at www.cornhole-game.org for the lowest prices on the internet. We have 12 colors, 90 day warranty, and we ship out products on the same business day. Feel free to go to the site and look around, and if you have questions about our product then give us a call.

If you can sew, then make each bag as follows:

Each bag (you need at least 8), will be made from 12 oz./sq. yard duck canvas and shall be made from 2 fabric squares, a minimum of 6" x 6" in dimension with a quarter inch double stitched seam on all four sides. Each bag shall be filled with corn feed and weigh between 14 and 16 oz's apiece.

Of course they can be any color or design, but make two different styles so that you can tell them apart during play.

NOW ENJOY THE FASTEST GROWING FAMILY GAME AROUND.....